



# **Warrior 400**

## **Electric Golf Trolley**

### **INSTRUCTION MANUAL**

400Ins03-06



## Trojan™ Warrior 400 Electric Golf Trolley

**Please Note:**

Due to continual improvement, the style of wheels may differ from the illustration in this manual.

## Assembling your Trojan 400 Warrior

You may have purchased your Trojan 400 Warrior from your supplier ready-assembled or it may have been delivered boxed.

In either instance you should have received the following parts:

- Trojan electric golf trolley
- 2 wheels (marked 'L' and 'R')
- 24 AH sealed battery with cover and fused lead
- Tool Bag containing:
  - Intelligent 3 stage charger
  - Pozidrive screwdriver
  - 2 spanners, spare fuses
  - Carry bag

If you received a boxed trolley, you will need to fit the wheels on the trolley.

### Fitting the wheels

When looking from the handle end of the trolley, the wheel marked 'L' is placed on the left-hand end of the axle, and the wheel marked 'R' on the right-hand end of the axle.

Each wheel has a release button near the centre of the wheel.



Hold this button down and push the wheel on to the end of the axle, ensuring that the drive pins on the axle engage in the slot on the inside wheel hub. Push the wheel fully on and then release the button. The wheel should 'click' into place and hold securely.

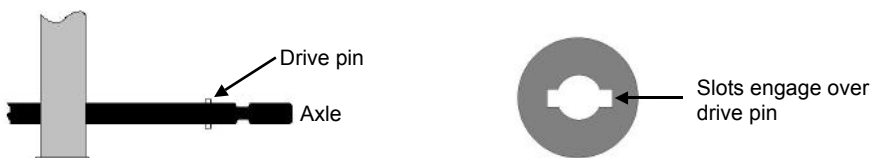

## Unfolding the trolley

Unfasten any of the bag straps holding the trolley in the folded position.

1. Pull up on the trolley handle and lift the main handle spar  
Upwards

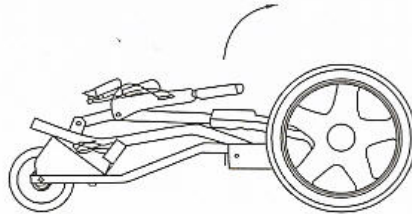

### IMPORTANT - RAISE BY PULLING ON THE HANDLE ONLY

2. Raise the main spar to vertical so that the latch engages with the slot in the support bracket



3. Flip the upper spar and engage the bag support over the main spar

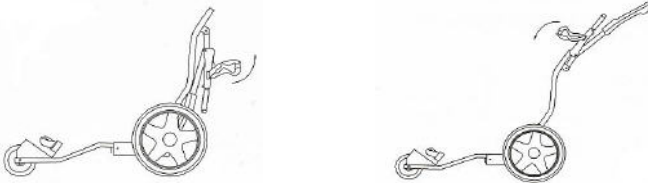

4. Secure the upper bag by locking the pin into the notch in the handle support. To disengage the pin, pull the pin downwards and release from the notch

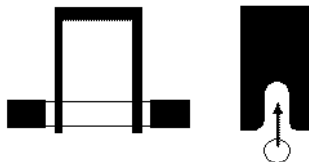

## Connecting the battery

Place the 28 AH battery in the tray at the centre rear of the trolley



Ensure that the speed control knob on the handle is turned to the 'off' position.

Attach the battery connector to the corresponding connector on the trolley, ensuring that it attaches 'red-to-red' and 'black-to-black'.

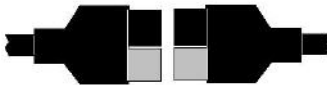

When disconnecting the battery, hold the connectors firmly by their black plastic sheaths and pull the connectors apart.

### **Safety First!**

Keep control of your trolley at all times. Hold the handle while the trolley is moving.

Do not allow your trolley to freewheel down hill.

Your trolley and bag/clubs etc will weigh in the region of 70kg. This can cause serious injury to other people. Please use your trolley responsibly.

Your warranty excludes misuse or accidental damage.

## Fitting your golf bag

Place your golf bag on the bag supports and secure with the velcro straps



Tighten the straps as necessary to hold your golf bag firmly in place.

We recommend a maximum weight for your bag, clubs and accessories of 24 kg (approx. 55lbs). The lighter your equipment, the further your trolley will travel on a single battery charge.

## Adjusting the left/right tracking

If your trolley pulls slightly to the left or right when in use, adjust the front wheel tracking. Loosen the locking nuts and then screw down the adjusting nut(s). If your trolley pulls to the left, tighten the right-hand adjusting nut and vice versa. Re-tighten the locking nuts once the adjustments have been made

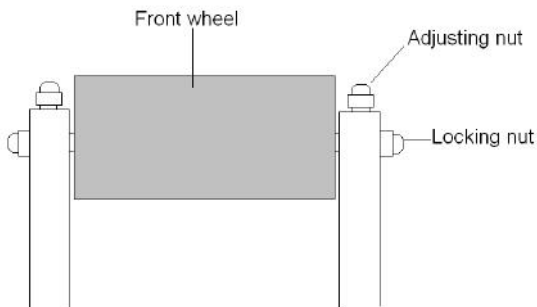

## Using your Trojan trolley

After connecting the battery, start your trolley by pressing the switch to the 'I' position. Turn the speed control knob on the handle away from you to increase the speed of your trolley

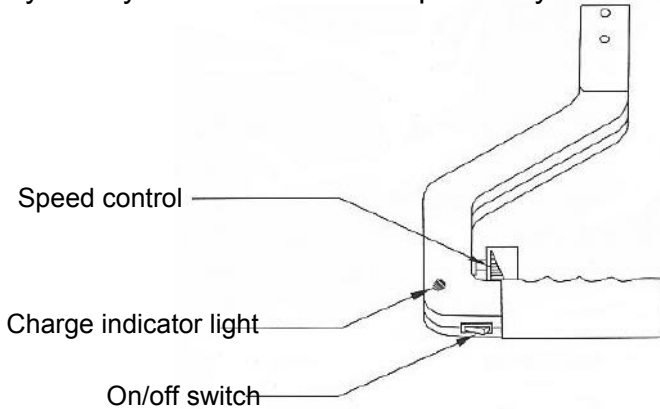

The more you turn the speed control, the faster your trolley will go, up to a maximum of 6km/hour. You can set the speed of your trolley to exactly match your walking pace.

To stop your trolley, turn the speed control knob towards you.

### Battery charge indicator light

Your Trojan trolley is fitted with a convenient battery charge indicator light on the handle.

This light has 3 indications:

Green - your battery is fully charged and properly connected

Blue - this is normal when your trolley is in use

Red - battery charge low; please charge your battery as soon as possible (you will have sufficient charge for approx 4 holes from when the indicator light first turns red)

## **Folding your trolley**

Remove your golf bag by unfastening the straps.

Disconnect the battery and remove it from the trolley.

Unlatch the handle safety clip

Lift and fold the upper bag support

Lift the handle retaining pin from the slot in the lower support bracket and fold the main spar forwards

Fasten the bag strap around the folded trolley - this holds the trolley in place making it easier to place it in the carry-bag.

## **Maintaining your trolley**

A build-up of mud on the wheels can affect the performance of your trolley and reduce battery life.

Wash off any excess mud or dirt with warm soapy water. We do not recommend the use of strong detergents or caustic cleaners.

Check occasionally to ensure that all nuts, bolts and screws remain tight.

The bearings on your trolley are sealed. However we do recommend that you occasionally lightly oil or grease the ends of the axle where the wheels are fitted.

We do not recommend the use of 'power washers' as the high pressure water may penetrate the weatherproofing on the electrical system.

If you intend to use a power washer, please ensure that the motor, control box, speed control and electrical connectors are protected before power washing. Water penetration of the electrical system may invalidate your warranty.

## Charging the battery

Please charge your battery as soon as possible after use - certainly within 48 hours - even if it has been used for only a few holes.

Your battery should be charged indoors in a cool, dry place and away from combustible materials.

Disconnect the charger from the mains power supply and connect it to the battery. Plug the charger in to the mains and switch on. The charger light will show red if the battery is not fully charged.

**IMPORTANT - If the charger light flashes red, disconnect immediately and check that the battery is wired correctly. If the problem continues, please call our Service Department.**

Whilst charging the red light will remain on for several hours until the battery is approx 90% charged and will then turn green. We recommend that you leave your battery on charge for a minimum of 6 hours.

You may leave the charger connected to the battery until you next use the battery. This will not harm the battery. However, we recommend that a battery left for any length of time - 3 months or longer - should be disconnected and recharged before use.

Switch off the charger and disconnect it from the mains before disconnecting the battery.

Do not leave your battery connected to the charger if the charger is not plugged in to the mains. This will cause your battery to discharge.

Do not leave your charger connected to the mains without the battery connected. This may cause the charger to overheat.

If you do not use your trolley for an extended period, please ensure the battery is charged at least once every 3 months.

Your battery is 'sealed-for-life' and requires no maintenance. Do not attempt to open the battery under any circumstances as it contains strong acid which may be harmful. If your battery casing becomes cracked through accidental damage, discard it immediately in a proper manner.

**Please note that for the first 5 or 6 charges, the red charger light may not turn green. Your battery will be fully charged after 6-7 hours. Switch off the charger and disconnect the battery after this time. Your charger/battery will work normally after several charges.**

Your battery is fully guaranteed for 12 months.

## Service & Fault-finding

If you are unsure about the correct operation of your **Trojan™** trolley, or encounter a problem that is not covered below, please call our Service Centre on 08701 432 599 where we will be delighted to help you.

### Fault finding

#### “My trolley does not switch on”

Please check:

- The battery is charged and properly connected
- The speed control knob turns properly
- The fuse on the battery lead has not ‘blown’  
(see fuse instructions)

#### “My trolley switches on (the motor turns) but the wheels don’t go round”

Please check:

- The wheels are properly engaged
- The wheels are fitted to the correct side of the axle
- The drive pins are not damaged

To check the drive pins, remove the wheel.

The drive pins protrude through the axle at right-angles to it.

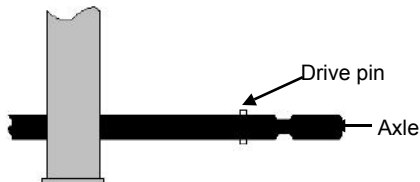

If they are damaged or missing, please call Service

The axle turns

If the motor turns, but the axle does not revolve, please check that the motor drive pin is not damaged.



If the motor drive pin is damaged or missing, please call Service

**“The trolley pulls strongly to the left/right”**

Adjust the front wheel tracking mechanism

Check that the axle pins are not damaged

Check that the front wheel is not damaged

If necessary, remove the wheels and apply a light coating of oil or grease to the ends of the axle

If the problem is not resolved, please call Service

**“My trolley does not manage 18 holes on one battery charge”**

Your battery may need 5-6 charges to operate at full capacity - this is normal for all batteries

Charge the battery for at least 6 hours

Check that the charger is working normally (see Charger Instructions)

Check for damage to the battery

Check the battery connection

Do not use a bag/clubs weighing more than 55lbs (25kg)

If the problem is not resolved, please call Service

**“My battery / charger gets hot when charging”**

Your battery and charger may become warm when charging (this is normal). However if either becomes hot, disconnect the battery and charger and call Service

**“My trolley goes slowly uphill”**

The gearing on your Trojan Warrior is set for optimum distance per charge and a good walking pace. On steep slopes you may find your trolley moves slowly, especially if you have a heavy bag. This is normal - it's like trying to go uphill with your car in high gear.

## Replacing the fuse on your Trojan™ Electric Trolley

The electronics and motor on your Trojan® electric golf trolley are protected by an in-line fuse on the positive (red) battery lead.

Should your Trojan® trolley refuse to operate, please check the fuse in the first instance.

- 1 Disconnect the battery.
- 2 Unzip the battery case and locate the in-line fuse.



- 3 The fuse is one of two types, either a glass cartridge fuse or a blade (auto) fuse.



- 4 Remove the fuse and check whether it is intact.
- 5 If the fuse is blown, replace it with one of the spare fuses provided. The fuse has a rating of 30 amps.
- 6 Zip up the battery case.
- 7 Reconnect the battery

## Battery Connections

Should you need to refit the battery cable, please ensure the following:

Black (-ve) lead must be connected to the (-ve), black battery terminal.  
 Red (+ve) lead must be connected to the (+ve), red battery terminal.  
 Pass the connector through the eyelet in the rainproof battery cover and zip up the cover.

## Trojan™ 2 year Warranty Statement

Your Trojan™ electric golf trolley is warranted against manufacturing defects and faulty materials for a period of 2 years from the original date of purchase.

During the first year we will repair your Trojan™ trolley, including all parts and labour costs, at our expense or we will replace it with a new trolley (at our discretion).

In the first year of the Warranty, should your trolley need to be returned to us for repair, we will arrange with you to collect your trolley and return it to you free of charge. We aim to return your trolley within 7 working days

In year two of the Warranty period, we will repair your Trojan™ trolley, including all parts and labour costs, at our expense or we will replace it with a similar or newer trolley (at our discretion) which may not be 'brand new' but which has been Factory Refurbished. Any replacement trolley provided will continue to be warranted until 2 years from the original date of purchase.

In the second year of the Warranty, should your Trojan™ trolley need to be returned to us for repair, we will arrange with you for the trolley to be collected and returned for a fixed carriage and administration fee which we will discuss with you prior to the repair. This fee will not exceed 20% of the original purchase price.

The following are excluded from the Warranty:

- Accidental damage or misuse.

- Immersion in water.

- Unauthorised modifications or unauthorised repairs.

- The use of non-original parts.

The battery, charger and carry-bag supplied with your Trojan™ electric trolley are warranted against manufacturing defects, faulty materials for a period of 1 year from the original date of purchase.

If your Trojan™ electric golf trolley needs to be repaired, in the first instance please call our Service Department on 08701 432 599 where we will be pleased to advise you. Please have your Warranty no. or original receipt to hand when you call.

This Warranty does not affect your Statutory Rights.

Date Purchased \_\_\_\_\_ Purchased from \_\_\_\_\_

## Some 'Do's and Don'ts' about using your Trojan™ trolley

### Do.....

- Charge the battery as soon as possible after each use (within 48 hours max)
  - Charge the battery for at least 6 hours
  - Clean off excessive dirt/debris with warm soapy water
  - Occasionally check nuts/bolts/fixings for tightness
  - Occasionally lubricate exposed bearings etc
  - Keep control of your trolley at all times
- Call Service on 08701 432 599 if you have any problems

### Don't.....

- Lift the folded handle assembly other than with the handle
- Attempt to lift the folded handle assembly from the front of the trolley!\*
- Allow your trolley to freewheel downhill
- Continue to run the motor for more than 4 holes after the 'red' indicator light comes on
- Use strong detergents or caustic chemicals to clean the frame
- Power-wash your trolley without protecting the electrical system
- Carry more than 55lbs (25 kg) of bag/clubs/ Accessories
- Use the charger if the charger light flashes red
- Allow children to sit or ride on the trolley

\*lifting the folded handle assembly from the front may trap the handle against the support bracket. Undue force may cause the handle to fracture

## Notes

This page is deliberately blank



For Service call

**08701 432 599**

Trojan Golf  
The Linden Building  
Regent Park  
Booth Drive  
WELLINGBOROUGH  
NN8 6GR

© Trojan Golf 2006